



WARRANTY

Register your product within 30 days of purchase to activate its one-year limited manufacturer's warranty at OVENTE.COM

WARRANTY IS ONLY VALID IF YOU REGISTERED WITHIN 30 DAYS AFTER PURCHASE.

LIMITED ONE (1) YEAR WARRANTY

Your product has a one (1) year warranty period from the date of purchase from an authorized retailer. In the event that the product is defective, feel free to contact us to arrange for a replacement. This warranty only covers defects in workmanship and materials. The warranty does not include damage due to abuse or misuse, any commercial use or accidents.

LIMITATIONS

The warranty stated above is the only warranty applicable to this product. Other expressed or implied warranties are hereby disclaimed. No verbal or written information given by the Manufacturer, its agents or employees shall create a guarantee or in any way increase the scope and duration of this warranty. Repair or replacement as provided under this warranty is the exclusive remedy of the consumer. The manufacturer shall not be liable for incidental or consequential damages resulting from the use of this product. Any implied warranty of merchantability or fitness for a particular purpose on this product is limited to the applicable warranty period set forth above except to the extent prohibited by law. Consumer rights may vary from state to state.

Customer Service: (855) 926-2626

Visit us at ovente.com

OVENTE®

Electric Water Boiler WA32 Series



Before using please read the instruction manual and keep it for future use.

IMPORTANT SAFETY NOTES

When using your water boiler, basic safety precautions should always be followed, including the following:

- Before using your water boiler, please read the instruction manual carefully.
- Check the main voltage whether it is the same as stated on your water boiler.
- Handle the power cord carefully. Do not bend or pull cord. Unplug from wall socket when not in use.
- Always use your water boiler in a vertical upright position.
- Water boiler may be deformed or damaged when exposed to heat or used in unstable surroundings (excess water or humidity).
- Boiling without any content could damage the unit.
- Avoid touching the outer body during operation. Always allow the boiler to cool before handling.
- Close supervision is necessary when water boiler is used by or near to children. Never leave the appliance unattended.
- Do not operate the water boiler with a damaged cord/plug, malfunctions or has damaged in any manner.
- Do not use unnecessary attachments that are not recommended by the manufacturer as may result in hazards.
- The water boiler is not intended for outdoor use or on damp areas. It is for household use only
- Power cord should not be knotted, left on hot surfaces or left hanging over table edges.
- Beware of the hidden steam under lid.
- Water boiler should be given ample air circulation on all sides.
- Do not use appliance for other than its intended use.

WATER BOILER MAINTENANCE

1. Remember to unplug power cord from wall socket and power inlet.
2. Detach upper lid and pour out remaining water.
3. If mineral deposits are accumulates, loud noises may be heard while boiling and you may face difficulties dispensing hot water. Regular cleaning will avoid such problems.
4. Wipe upper lid and body with a damp cloth.
5. Never immerse any part of the water boiler in water.
6. Do not use abrasive materials to clean appliance.

Discoloration of the inner container and white particles floating in the water.



- Red rust-like spots, milky or black discoloration, and white floating objects are caused by minerals in the water.
- Cut a lemon into four pieces, wrap the lemon in the cloth and place in the inner container.
- Pour water up to the full level into the inner container.
- Boil and then retain heat for about one hour.
- Pour out the water and use a nylon brush to clean the container.
- To remove the smell of the lemon, boil water again and dispose the water.

ELECTRICAL REQUIREMENTS: 120V ~ 60Hz, 700W

RE-BOIL THE HOT WATER UNDER THE KEEP WARM MODE

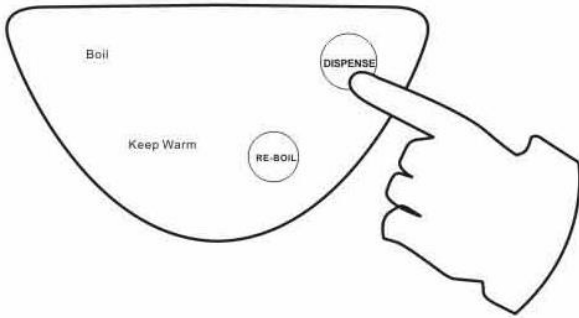

- Re-boiling a full container takes about 3 minutes.
- Before re-boiling, make sure the water level is above the refill mark.
- The re-boil key may have no effect right after the water has boiled.
- Once the re-boil button is pressed, the boiling process cannot be reset until the water boiler automatically switches to the keep warm mode.
- Do not press the re-boil button repeatedly, as the continuous boiling process will cause malfunction.

AFTER USE

Unplug the power cord then remove the lid and dispose the water.

- Allow the boiler to dry thoroughly.
- Do not place in a dishwasher; this will damage the boiler.

Detaching Top Lid

<p>1</p>		<p>Place the handle towards the rear side of the water boiler. Press the outer hinge.</p>
<p>2</p>		<p>Lift knob lid lock to release the top lid.</p>
<p>3</p>		<p>Pull lid out of the securing hinge. Never remove lid while the appliance is operating. Beware of hidden steam.</p>

Attaching Top Lid

Place the handle towards the rear side of the water boiler. Insert the shaft of the outer hinge on the lid into the hinge holder. Close and press on lid until it clicks.

- Place steam vent of the lid away from any outlet and any furniture.
- Handle power cord carefully, cord may malfunction if dropped.
- It is normal for smoke and smell to be emitted during first use, be cautious it will stop after a short period of usage.
- Be careful when moving water boiler filled with hot liquid.
- Do not fill the device more than the "Full" indicator scale.
- Do not cover steam vent with any flammable material.
- Always ensure that the water boiler lid is closed properly.
- Make full use of handle when moving the water boiler around.

HAZARDS

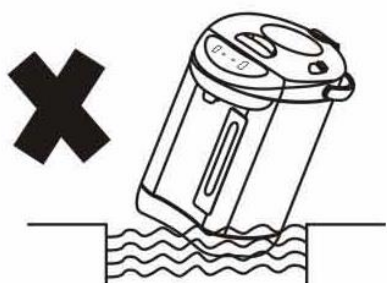

Do not immerse base, cord or plug in water or other liquid to protect against electric shock.

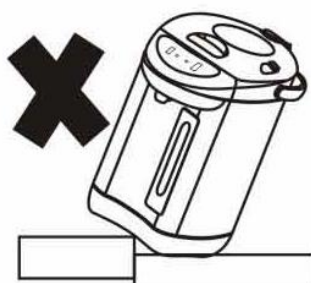

Do not place the water boiler on unstable surfaces.



Only fill with pure water (not milk or any other liquid).



Do not fill the Water Boiler above the maximum level mark inside the tank or lower than the minimum level to avoid any damages to the appliance.

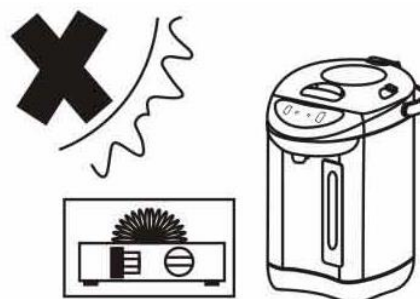

Do not place on or near a hot gas or electric burner, or a heated oven.

WATER BOILER PARTS

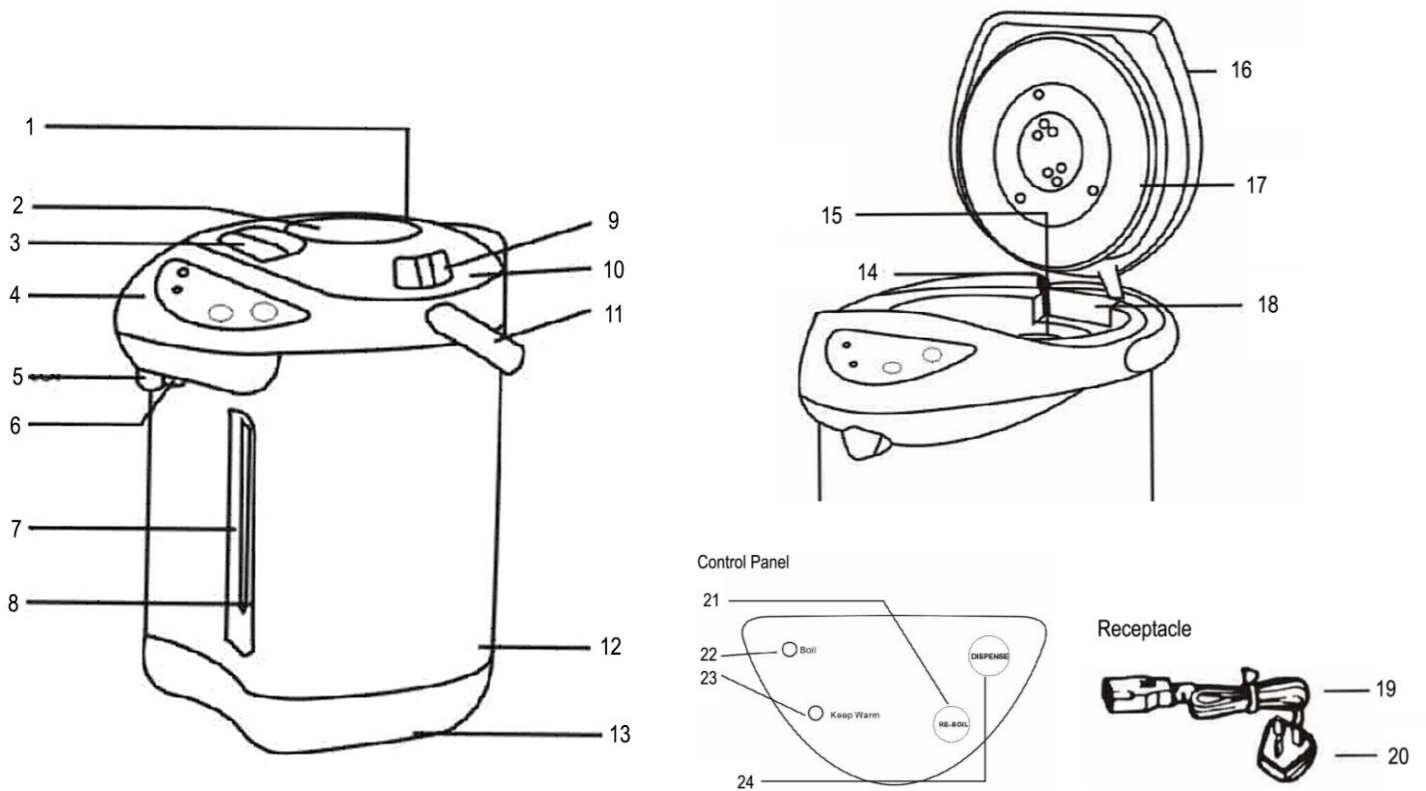



- | | | |
|-----------------------|-----------------------------|-------------------------------|
| 1. Steam Escape Holes | 10. Upper Lid | 18. Water Tank |
| 2. Water Pump Lid | 11. Handle | 19. Power Cord |
| 3. Knob of Lid Lock | 12. Power Inlet | 20. Plug |
| 4. Control Panel | 13. Rotating Base | 21. Re-boil Button |
| 5. Spout | 14. Upper Lid Hinge | 22. Boil Light Indicator |
| 6. Cup Switch | 15. Full Mark | 23. Keep Warm Light Indicator |
| 7. Water Level Gauge | 16. Detachable Upper
Lid | 24. Auto Dispense
Button |
| 8. Empty Mark | 17. Gasket | |
| 9. Pump Lock | | |

USING THE WATER BOILER

Using the Water Boiler for the First Time

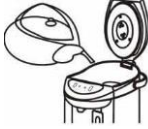
1. Wash and rinse inner tank with water.
2. Fill water up to "Full" line indicator.
3. Boil once and discard water by pumping it out.

<p>OPENING TOP LID Place the water boiler on a flat surface. Open top lid and fill with water to your desired capacity.</p> 	<ul style="list-style-type: none"> ● Always fill the water between the minimum and maximum water level line indicator.
<p>CLOSING TOP LID Carefully close lid by pressing down until a click sound is heard.</p>	<ul style="list-style-type: none"> ● Do not close the upper lid forcefully. (Hot water may gush out and cause scalds.)
<ol style="list-style-type: none"> 1. Insert the receptacle fully into the boiler's power inlet then plug into the wall socket. 2. Do not switch ON. When the container is empty. 	<ul style="list-style-type: none"> ● When rotating the body, be careful that the power cord does not get in the way.
<p>BOIL → KEEP WARM</p> <p>● ○</p> <p>BOIL BOIL</p> <p>○ ●</p> <p>KEEP WARM KEEP WARM</p> <ol style="list-style-type: none"> 1. "Boil" light is on during boiling process. 2. It will switch to "keep warm" automatically after the water is boiled. 	<ul style="list-style-type: none"> ● Do not open the upper lid during boiling process. ● Do not touch the steam coming out of the steam vent. ● Do not cover the steam vent with any flammable items. ● Do not dispense hot water while the water is boiling.
<p>POURING HOT WATER</p> <ol style="list-style-type: none"> 1. The hot water might not dispense smoothly right after boiling. 2. Press on the "AUTO DISPENSE" button to dispense hot water. 	<ul style="list-style-type: none"> ● CAUTION: Always keep the lid away from you as there is hot steam trapped under the lid. ● Do not press the dispensing button when the inner water reservoir is empty. (Doing so can cause damage.) ● You cannot dispense hot water if the water boiler is unplugged.